



Radio | CD | SD | USB | MP3 | WMA

Memphis MP66

7 646 520 310

7 646 521 310

Operating and installation instructions



<http://www.blaupunkt.com>

 **BLAUPUNKT**

Contents

About these instructions	70
For your safety	70
Scope of delivery	71
Warranty	71
Device Overview	72
Controls	72
Placing the device in operation	73
Detaching/attaching the control panel.....	73
Switching the device on/off.....	74
General functions	74
Inserting a CD.....	74
Inserting an MMC/SD card	75
Connecting the USB medium.....	75
Adjusting the volume	76
Muting the device	76
Operation with telephone.....	76
Selecting an audio source	77
The tuner display.....	78
The audio CD display	78
The CD changer display	79
The MP3 display	79
Overview of the operation	80
Overview of the buttons	80
Overview of the functions MIX, RPT, and TA.....	81
Switching random track play on/off (MIX)	81
Switching Repeat title on/off (RPT)	82
Scanning titles (Scan)	82
Buttons for menu operation	82
Example of a menu operation.....	83
Calling up a menu	83
Selecting a menu item in the settings menu.....	83
Changing and saving a setting.....	84
Exiting a menu item.....	84
Operating the tuner	85
Searching for stations.....	85
Manually searching for stations....	85
Automatically searching for stations	86
Storing stations	87
Listening to stored stations	87
Scanning all receivable stations	87
Set the device to the region Europe, USA or Thailand	88
Changing the tuner settings ("Tuner" menu)	89
Changing the waveband (Band) ...	89
Toggle between mono and stereo operation (Mono).....	90
Switching the display of radio text on/off (Radio Text).....	90
Allowing alternative frequencies (RDS)	90
Searching FM stations automatically and storing them in the FMT memory bank (Travelstore).....	90
Activating/deactivating improved reception (Hicut).....	91
Allowing/preventing automatic changing to other regional programmes (Regional).....	91
Changing the seek tuning sensitivity (Sensitivity).....	92
Restricting station seek tuning to certain programme contents (Program Type)	92

Traffic announcements (TA)	93
Receiving traffic announcements.....	93
Skipping a traffic announcement.....	93
Permanently switching the priority of traffic announcements on/off.....	93
Operating the integrated CD player.....	95
What features do MP3 or WMA CDs have to have?.....	95
Functions of the integrated CD player if an audio CD is inserted ..	96
Switching the CD text display on/off (TXT)	97
Switching the scrolling text for CD text on/off (SCL)	97
Operating the MP3/WMA player	98
Showing all the information of the current title (ALL)	99
Switching scrolling text on/off (SCL).....	99
Selecting the title information to be displayed (INF).....	99
Selecting a title from a list (Browser mode/playlist)	100
Operating the optional CD changer	102
Changing the name of a CD in the magazine of the CD changer (CDN)	103
Changing basic settings in the settings menu	104
Adjusting sound and balance (Audio Settings).....	105
Changing treble or bass (Treble/Bass)	105
Changing the volume distribution (Balance/Fader).....	105
Changing the equalizer setting (Digital Equalizer)	106
Calling up a user-defined equalizer setting (User Equalizer)	106
Creating/changing a user- defined equalizer setting (Adjust)	107
Which equalizer setting is the correct one?	109
Selecting a sound preset (Presets)	110
Setting the speed-dependent volume increase (Auto Sound) ...	110
Setting the bass increase (X-Bass).....	110
Switching off the equalizer	110
Configuring the preamplifier output for the subwoofer (Subout).....	111
Changing display settings (Display Settings)	112
Changing the brightness of the display for day/night (Brightness)	112
Activating/deactivating the screen saver (Screen Saver)	112
Switching the welcome text on/off (Turn On Text)	112
Changing images and animations (SD Browser/USB Browser)	113
Adjusting the display viewing angle (Angle).....	114
Changing volume presettings (Volume Settings).....	115
Changing the volume presetting of traffic announcements (Traffic Volume).....	115
Changing the volume presetting of the telephone (Phone Volume)	115

Changing the volume presetting of the signal tone (Beep Volume)	116	Changing the scan time (Scan Time).....	121
Changing the presetting of the power-on volume (On Volume)...	116	Displaying the serial number (Serial Number)	122
Restoring the volume at switch-on (Last Volume)	116	Error table	122
Changing clock settings (Clock Settings)	117	Specifications	123
Setting the time (Time Setting)	117	Glossary	124
Switching the time display on/off with switched-off device (Off Clock)	117	Index	127
Configuring audio inputs (Aux Settings)	118		
Switching the RDS synchronisation of the clock on/off (Auto Sync)	118		
Switching the 24-hour time display on/off (24 h Mode)	118		
Activating/deactivating audio inputs (Auxiliary 1/2)	119		
Renaming audio inputs (Edit Auxiliary 1/2)	119		
Changing special settings (Various Settings)	120		
Changing the welcome text (Turn On Text)	120		
Switching the internal amplifier on/off (Internal Amp)	121		
Resetting the device to factory settings (Norm Set).....	121		

Blaupunkt stands for technical know-how in mobile radio reception, for precise navigation systems and first-class sound. The blue dot made its debut in 1923 as a seal of quality that was assigned after rigorous functional – and it still applies today. At that time as well as today, the blue dot identifies products of extraordinary quality.

About these instructions

Please read these instructions and, in particular, the following chapter, "For your safety", before using the device! Please also observe the following instructions:

- CD Changer, if available
- Remote Control, if available

For your safety

The device was manufactured according to the state of the art and established safety guidelines. Even so, dangers may occur if you do not observe these safety information:

- Read these instructions carefully and completely before using the device.
- Keep the instructions at a location so that they are always accessible to all users.
- Always pass on the device to third parties together with these instructions.

Use as directed

The device is designed for operation in a vehicle with 12 V vehicle system voltage and must be installed in a DIN slot.

If you are installing device yourself

You may only install the device yourself if you are experienced in installing car sound systems and are very familiar with the electrical system of the vehicle.

Observe the following!



Danger of injuries!

Do not open or modify the device! The device contains a Class 1 laser that emits invisible laser radiation which can cause injuries to your eyes. The warranty is void if the device has been opened.



Danger of accidents!

Operate the device only if traffic situation permits it!



Danger of hearing damage!

Always listen at moderate volume so that you can always hear acoustic warning signals! This will also help to protect your hearing. The device briefly switches to mute, e.g. while the CD changer changes the CD or if you are switching the audio source. Do not increase the volume during this mute phase



Danger to the device!

Do not insert any mini CDs (8 cm diameter) and shape CDs since they destroy the drive!

Theft protection

Carry the control panel with you in the supplied case whenever you leave the vehicle.

Cleaning

Clean the device with a dry or slightly moistened cloth. Do not use any solvents, cleaning agents or cleansers and no cockpit spray and care product for plastic materials.



Disposal of old unit (EU countries only)

Do not dispose of your old device in the household trash!

Use the return and collection systems available to dispose of the old device.

Scope of delivery

- 1 Memphis MP66
- 1 Case for the control panel
- 1 Operating instructions
- 1 Support frame

- 2 Disassembly bar
- 1 Guide pin
- 1 USB connecting cable

Note:

Remote controls are available as optional equipment. You can find out from your Blaupunkt dealer or on the Internet at www.blaupunkt.com which remote controls can be used with this device.

Warranty

We provide a manufacturer's warranty for products bought within the European Union. For devices purchased outside the European Union, the warranty terms issued by our respective responsible domestic agency are valid.

The warranty terms can be called up under www.blaupunkt.com or requested directly from:

Blaupunkt GmbH
Hotline
Robert-Bosch-Str. 200
D-31139 Hildesheim

Device Overview

Controls

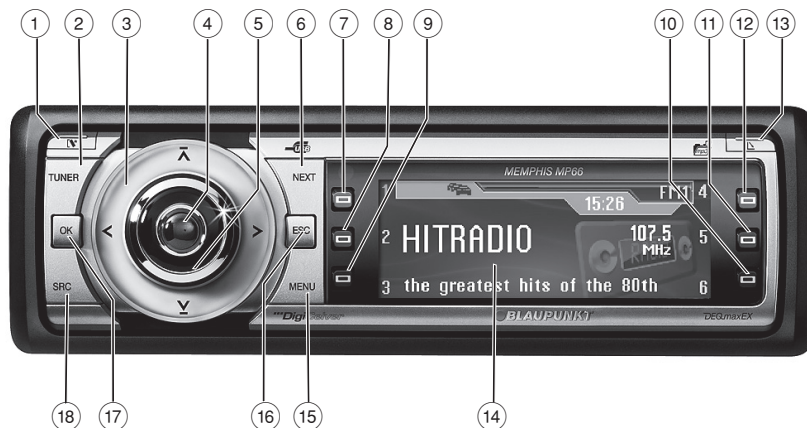

- ① **⏏** button
for detaching the control panel
- ② **TUNER** button
Selecting the tuner as audio source
Opening the "Tuner"
- ③ Rocker switch
Tuner: Start the station seek tuning
Settings menu: Change settings
- ④ On/Off button
Press short: Switch on/mute
Press long: Switch off
- ⑤ Volume control
- ⑥ **NEXT** button
Tuner: Select memory bank (FM1, FM2, FM3, FMT)
Settings menu: Go to the next menu page
MP3/WMA: Switch between "PLAY", "BROWSER" and "PLAYLIST"
- ⑦ to ⑫ Softkeys
To select the function shown on the display next to the respective button
- ⑬ **⏏** button
to eject/insert a CD
- ⑭ Display (see page 78 and 79)

- ⑮ **MENU** button
to call up the settings menu
- ⑯ **ESC** button
Settings menu: Confirm menu item and change to the display of the audio source
Scan/Travelstore: Cancel
- ⑰ **OK** button
Press short: Confirm menu item and change to the next higher menu level
Press long: Start scan/station seek tuning
- ⑱ **SRC** button
consecutively switching between the available audio sources
- ⑲ CD drive



- ⑳ MMC/SD card slot

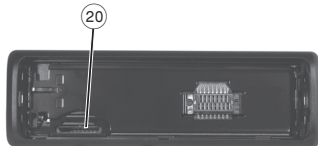

Placing the device in operation

Detaching/attaching the control panel

You can detach the control panel to protect against theft.



CAUTION!

Danger of theft!

The device is worthless to a thief without the control panel.

- Never keep the control panel in the vehicle, not even in a hidden place; instead, carry it with you in its case when you leave the vehicle!



CAUTION!

Damage to the control panel!

The control panel can be damaged or malfunction if the following is not observed:

- Never drop the control panel.
- Never expose the control panel to direct sunlight or another heat source.
- Transport it exclusively in the supplied case.

General functions

- Do not touch the contacts on the rear side with your fingers.
- Clean the contacts of the control panel regularly using a soft cloth moistened with cleaning alcohol.

To detach the control panel:

- Press the  button ①.
The control panel opens to the front on the left. The device switches off automatically.

→ Detach the control panel.

To attach the control panel:

- Place the control panel in the slot with the right side first.
- Next, carefully push the left side to the back until the control panel engages.

Switching the device on/off

To switch on the device:

- Press the On/Off button ④.
The device plays the audio source you previously listened to.

Note:

If you switch on the device without first switching on the vehicle ignition, the device automatically switches off after one hour to save the vehicle battery.

To switch off the device:

- Press and hold the On/Off button ④ for approx. two seconds.

In addition, the device is automatically switched off as soon as you switch off the vehicle ignition. If you switch on the ignition again, it also automatically switches on the device again.

General functions

Inserting a CD



CAUTION!

Damage to CD drive from unsuitable CDs!

Mini CDs (8 cm diameter) or shape CDs damage the drive!

- Insert only circular CDs with a 12-cm diameter into the CD drive.

To insert an MP3, WMA or audio CD, the device must be switched on.

- Press the  button ⑬.

The control panel opens. If a CD is in the drive, it is ejected. If you do not remove this CD, it is automatically pulled in again after approx. 10 seconds.

- Insert the CD with its printed side uppermost into the CD drive (19) until you feel some resistance.

The CD is automatically drawn in and the control panel closes. This CD can now be selected as audio source.

Note:

As long as the CD is in the drive, the device stores track and playing time of the CD played last, and after calling up the audio source, the playback starts at the position where it was interrupted.

Inserting an MMC/SD card

Note:

Blaupunkt cannot guarantee the correct functioning of all MMC/SD card available on the market and, for this reason, recommends the use of MMC/SD cards manufactured by "SanDisk" or "Panasonic". The cards must be formatted using the FAT16 or FAT32 file system and contain MP3 or WMA files.

- Remove the control panel as described on page 9.
- Insert the MMC/SD card in the card slot (20) until it engages. The contacts of the card must point down and to the rear.
- Attach the control panel as described on page 9.

This MMC/SD card can now be selected as audio source.

To remove the MMC/SD card:

- Remove the control panel as described on page 9.
- Push on the MMC/SD card until it disengages.
- Pull the MMC/SD card out of the card slot (20).

Connecting the USB medium

To be able to connect a USB stick or a USB 2.0 hard disk, the supplied USB cable must be connected to the rear side of the device before the installation as described in the installation instructions. This cable can be routed, for example, to the glove compartment or a suitable place of the center console.

Note:

Always switch off the device before connecting or disconnecting the USB medium.

→ Connect the USB medium to the USB cable that is routed from the rear side of the device.

The USB medium can now be selected as audio source.

For the device to recognise the USB medium, it must be specified as mass storage device and formatted using the FAT16 or FAT32 file system and contain MP3 or WMA files. Blaupunkt cannot guarantee the proper functioning of all USB media available on the market. If extensive files are stored on your USB 2.0 medium, the file search (see page 100) can be slow.

Adjusting the volume



WARNING!

Danger from excessive volume!

Excessive volume can damage your hearing and you may fail to hear acoustic warning signals!

- Do not change the volume while the device changes the CD in the CD changer or the audio source.
 - Always set the device to a moderate volume.
-

→ Turn the volume control ⑤.

The current volume is shown on the display and used for all audio sources.

Note:

To preset the volume of traffic announcements (Traf), a connected telephone (Phone) and the signal tone (Beep), see page 115 and 116.

Muting the device

The device can be muted as follows:

→ Briefly press the On/Off button ④.

The display shows "MUTE".

To cancel the mute function:

→ Briefly press the On/Off button ④ again or turn the volume control ⑤.

Operation with telephone

If a hands-free system is installed in your vehicle or your cell phone is connected to the device via a Bluetooth adapter, the device responds as follows to incoming or outgoing telephone calls:

- The voice of the person calling you is played back via the loudspeakers of the vehicle,

- The display shows "Phone call".
 - The currently playing audio source is muted.
 - During the telephone call, you change the volume of the telephone call by means of the volume control ⑤.
 - Traffic announcements (TA) are not automatically shown.
- To be able to select an external audio source, it must be connected and contain audio data.
- Press the **SRC** button ⑱ repeatedly until the display briefly shows the desired audio source.

Selecting an audio source

The device features the following audio sources:

- Tuner
- Integrated CD player (can play audio CDs as well as CDs with MP3 or WMA files)
- MMC/SD card with MP3 or WMA files

In addition, the following external audio sources can be connected:

- either an optional CD changer or AUX 1
- AUX 2 (e.g. MiniDisc or external MP3 player)
- USB medium with MP3 or WMA files

The tuner display

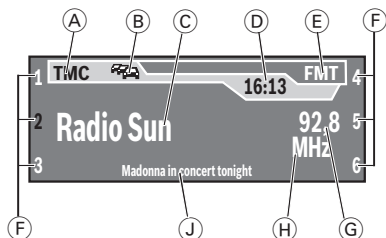

- (A) TMC symbol¹⁾
- (B) TA symbol
see page 93
- (C) Main line
RDS station name or frequency
- (D) Clock
- (E) Level indicator
Memory bank (FMT, FM1 to FM3)
- (F) Memory location for radio stations which can be selected using the six softkeys (7) to (12)
- (G) Info line 1
Frequency of the station
- (H) Info line 2
Frequency unit (MHz or kHz)
- (J) Info line 3
Radio text, if supported by the station

The audio CD display

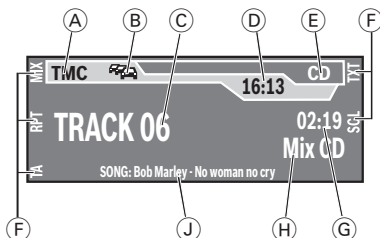

- (A) TMC symbol¹⁾
- (B) TA symbol
see page 93
- (C) Main line
Track number
- (D) Clock
- (E) Level indicator
Audio source (CD)
- (F) Functions which can be selected using the softkeys (7) to (12)
- (G) Info line 1
Playing time
- (H) Info line 2
Activated audio functions
- (J) Info line 3
CD text

¹⁾ The TMC symbol appears only if you connect an external navigation system and it starts searching for TMC stations.

The CD changer display

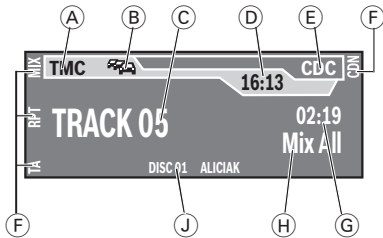

- (A) TMC symbol¹⁾
- (B) TA symbol
see page 93
- (C) Main line
Track number
- (D) Clock
- (E) Level indicator
Audio source (CDC)
- (F) Functions which can be selected using the softkeys (7) to (12)
- (G) Info line 1
Playing time
- (H) Info line 2
Activated audio functions
- (J) Info line 3
CD text or CD name

The MP3 display²⁾

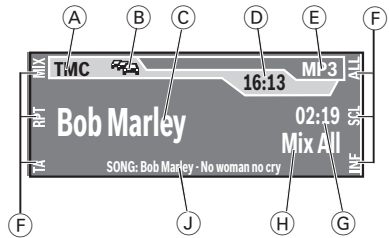

- (A) TMC symbol¹⁾
- (B) TA symbol
see page 93
- (C) Main line
ID3 or file name
- (D) Clock
- (E) Level indicator
Audio source (MP3, MMC, USB)
- (F) Functions which can be selected using the six softkeys (7) to (12)
- (G) Info line 1
Playing time
- (H) Info line 2
Activated audio functions
- (J) Info line 3
Title information (e.g. ID3 or file names)

²⁾ The MP3 display appears of a CD, SD/MMC card or USB medium with MP3 or WMA files is inserted and selected as audio source. The corresponding MP3 medium is displayed on the level indicator (E).

Overview of the operation

This chapter first presents the buttons on the device.

It is followed by a description of the audio functions MIX, REPEAT, TA and SCAN since their operation is identical for all audio sources.

The operation of the device menus is described starting on page 82.

Overview of the buttons

Many basic functions during the playback of music, such as forwarding and reversing music, are performed using the rocker switch ③ (using the four functions >, <, $\bar{\wedge}$, and $\bar{\vee}$), the **OK** button ⑰ or the six softkeys ① ⑦ to ⑫.

Note:

These functions are **not** shown on the display!

The following table shows the functions that can be performed by these buttons.

What do you want to do?	Selectable audio sources					
	Tuner	CD	MP3/WMA	CDC	AUX	
Forward	–	Hold > pressed			No operation possible of Memphis	
Reverse	–	Hold < pressed				
Title forward	–	> Press short				
Title reverse	–	Press short <				
Previous CD/folder	–	–	$\bar{\wedge}$ Press short			
Next CD/folder	–	–	$\bar{\vee}$ Press short			
Scan track/station (see also page 82)	Press OK for 2 s					
Play radio station	① Press short	–	–	–		
Store radio station	Press ① for 2 s	–	–	–		

Overview of the functions MIX, RPT, and TA

The display of the active audio source can show up to six functions (F) at the left and right edge of the display which you always operate using the same six softkeys (7) to (12) independent of the audio source. The different settings of a function are selected by repeatedly pressing the same softkey.

The following table shows which settings are available for the functions MIX, REPEAT, and TA.

Softkey next to the audio function	Selectable audio sources					
	Tuner	CD	MP3 CD	USB/SD/MMC	CDC	AUX
MIX (random track play) (see also page 81)	-	OFF CD	OFF FOLDER CD	MEDIUM OFF FOLDER	OFF ALL CD	No operation possible of Memphis
RPT (repeat mode) (see also page 82)	-	OFF TRACK	OFF DIR TRACK	OFF DIR TRACK	OFF FOLDER CD	
TA (traffic announcement) (see also page 93)	OFF ON					

Switching random track play on/off (MIX)

→ Press the softkey (7) (next to "MIX").

The random track mode is briefly displayed.

- "MIX CD": All tracks on the current audio CD are played in random order.
- "MIX ALL": All tracks on all CDs in the magazine of the

CD changer are played in random order.

- "MIX FOLDER": Up to 99 MP3 or WMA titles in the current folder are played in random order.
- "MIX MEDIUM": All MP3 or WMA titles on the current data carrier (CD, MMC/SD card or USB medium) are played in random order.

- "MIX OFF": The random track play is switched off. All titles are played in the order in which they are found on the data carrier.

If you switched on random track play, the selected random track play mode is displayed on info line 2 (H) and indicated by "MIX" at the side of the display.

Switching Repeat title on/off (RPT)

→ Press the softkey (8) (next to "RPT").

The repeat mode is briefly displayed.

- "REPEAT TRACK": The current track is repeated until you quit repeat.
- "REPEAT DIR": All titles in the current folder are repeated until you quit repeat.
- "REPEAT CD": All tracks on the CD are repeated until you quit repeat.
- "REPEAT OFF": The repeat mode is switched off. However, the playback does not stop with the last track. After the last title in the last folder, the playback is continued with the first title in the first folder.

The selected repeat mode is displayed on info line 2 (H) and indicated by "RPT" at the side of the display.

Scanning titles (Scan)

You can scan all the titles of a data carrier. The scan time is selected in the settings menu ("Scan Time" menu item, see page 120 and 121).

→ Press and hold the **OK** button (17) for approx. two seconds.

All titles are scanned. The display shows "SCAN" and the display of the active audio source.

To cancel the scan:

→ Press the **OK** button (17).

The playback of the current title is continued.

Buttons for menu operation

The device features menus which allow you to change the presettings or make a selection. The display shows up to six menu items. Each menu item is assigned to one of the six softkeys (7) to (12).

The following buttons are required to operate the menus:

- The **MENU** button (15) calls up the settings menu at any time.
- If a menu consists of several pages, you can consecutively scroll them using the **NEXT** button (6).
- If "Tuner" is selected as the audio source, the **TUNER** button (2) calls up the "Tuner" menu.
- The softkeys (7) to (12) are used to select the menu items that are shown on the display next to the corresponding button.
- In some menus, the rocker switch (3) is used to change the setting of a menu item.

This setting is immediately effective and automatically stored.

- You confirm the setting with the **OK** button (17) and go back one higher menu level.
- You also confirm the displayed setting with the **ESC** button (16), but you are leaving the menu and return to the display of the active audio source.
- If you do not press any button, the display of the active audio source automatically appears after approx. 16 seconds.

Example of a menu operation

The following example from the settings menu (Changing the display brightness) shows how to operate the menus in general.

Calling up a menu

→ Press the **MENU** button (15).

The settings menu is displayed.

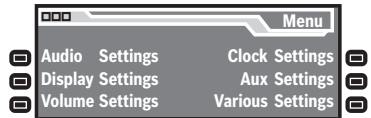

Selecting a menu item in the settings menu

→ Press the softkey (8) (next to "Display Settings").

The "Display" menu appears.

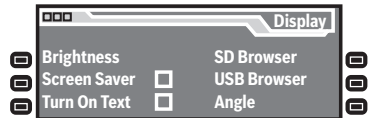

→ Press the softkey (7) (next to "Brightness").

The current settings for display brightness for "Night" and "Day" appear on the "Display" menu. The "Night" menu item is highlighted.

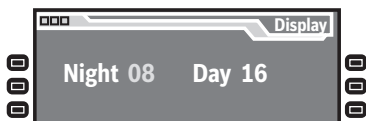

Since you can adjust the display brightness separately for night and day, you must switch between the menu items "Night" and "Day".

→ For this purpose, press the rocker switch (3) for > or < until the desired menu item is highlighted.

Changing and saving a setting

To change the display brightness:

→ On the rocker switch (3), press on $\bar{\Delta}$ or ∇ .

The setting takes effect immediately (the display becomes brighter or darker). The setting is saved.

If you do not press another button, the display of the active audio source automatically appears after approx. 16 seconds.

Exiting a menu item

→ Press the **OK** button (17) to go up one menu level.

→ Or press the **ESC** button (16) to exit the menu and return to the display of the active audio source.

Operating the tuner

After selecting "Tuner" as the audio source, the tuner display appears (see page 78). The playback starts immediately with the previously played station if the vehicle is within the reception area of this station.

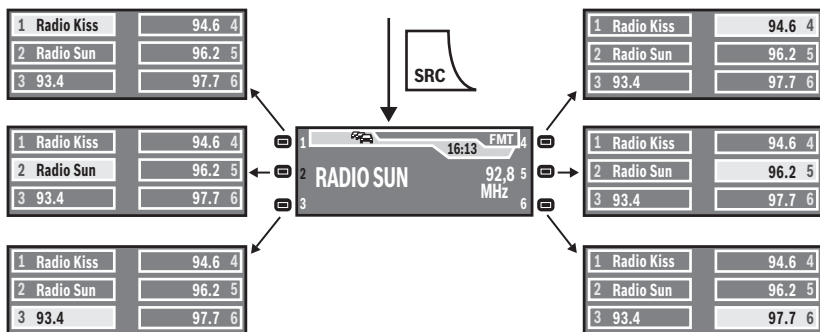

Selecting the memory bank

The device features four memory banks (FM1, FM2, FM3, and FMT). You can store or call up six stations at every memory bank.

To select the memory bank:

- Press the **NEXT** button (6) repeatedly until the desired memory bank appears on the level display (E) of the tuner display.

Searching for stations

You can search for stations manually or automatically.

Note:

To automatically search for FM stations and store them in the FMT memory bank (Travel-store), see page 90.

Manually searching for stations

- While the tuner display appears, press on > or < on the rocker switch (3).

The response of the tuner depends upon the settings in the menu "RDS" (see page 90) and "Program Type" (see page 92).

- If you selected a specific program type (PTY, e.g. news,

sports, classic, etc.) in the "Program Type" menu, the tuner automatically searches the next station broadcasting this program type in the selected direction. For this purpose, the station must be broadcasting the corresponding PTY identification as RDS service.

- If you activated the automatic change to alternative frequencies in the "RDS" menu, the tuner searches for the same station on a different frequency.
- If you selected the "PTY OFF" option in the "PROG TYP" menu and deactivated the automatic change to alternative frequencies in the "RDS" menu, you can manually adjust the tuner in increments of 100 kHz.

As soon as a station has been located, it is played. The station name appears on the display after a few seconds if the station provides this RDS information.

You can now store this station (see the next section) or restart the manual station seek tuning.

Automatically searching for stations

→ While the tuner display appears, press on $\bar{\Delta}$ or ∇ on the rocker switch (3).

The tuner searches for the next station in the current waveband in the selected direction. The settings in the menus "Sensitivity" (see page 92) and "Program Type" (see page 92) are incorporated.

As soon as a station is located, the seek tuning stops and the located station is played. The station name appears on the display after a few seconds if the station provides this RDS information.

You can now store this station (see the next section) or restart the automatic station seek tuning.

Note:

If you press and hold $\bar{\Delta}$ or ∇ on the rocker switch (3), the automatic seek tuning skips the stations found until you release the rocker switch again.

Storing stations

After locating a station, you can store it as follows:

- Select the desired memory bank (see page 85).
- Press the softkey for approx. two seconds to which you want to assign the station.

The station is stored. A signal tone confirms that the station has been stored.

The display briefly shows the assignment of the six memory locations of the current memory bank. The current station is highlighted.

Note:

To automatically search for FM stations and store them in the FMT memory bank (Travel-store), see page 90.

Listening to stored stations

- Select the desired memory bank (see page 85).
- Briefly press the softkey which is assigned to the station you want to set up.

The display may briefly show the assignment of the six memory locations of the current memory bank. The current station is highlighted. The desired

station is played back provided that it can be received at the current vehicle position.

- Press the **OK** button (17) or the **ESC** button (16) or wait for 16 seconds.

The tuner display shows station name, frequency and radio text of this station, provided that the station broadcasts RDS information.

In addition, the memory location of the radio station (F) is highlighted.

Scanning all receivable stations

- Select the waveband (FM, MW, LW) whose receivable stations you want to scan (see page 89).
- Press and hold the **OK** button (17) for approx. two seconds.

The tuner searches for stations in the current waveband. The display shows "SCAN" every two seconds.

As soon as the tuner has located a station, it is played and the station name or the station frequency appears on the display. The scan time can be set as described on page 120 and 121 under "Scan Time".

After the frequency band has been completely searched

once, the search stops and the station located last is played back.

You can do the following at any time:

- store the currently scanned station (see page 87),
- cancel the scan by briefly pressing the **OK** button (17).

Set the device to the region Europe, USA or Thailand

The device is factory set to the frequency ranges and station technologies of the region in which it was purchased. If this setting is not correct, you can adjust the device as follows to the different frequency ranges and station technologies of Europe, the United States or Thailand.

- Switch off the device.
- Hold the two softkeys (9) and (12) pressed while switching on the radio.

The "Area" menu opens.

- Press the softkey next to the region in which you are using the device.
- Press the **OK** button (17).

Changing the tuner settings ("Tuner" menu)

The "Tuner" menu allows you to change the basic settings of the tuner. To open the "Tuner" menu:

→ Press the **TUNER** button (2).

The "Tuner" menu appears.

The "Tuner" menu consists of two pages which can be toggled with the **NEXT** button (6).

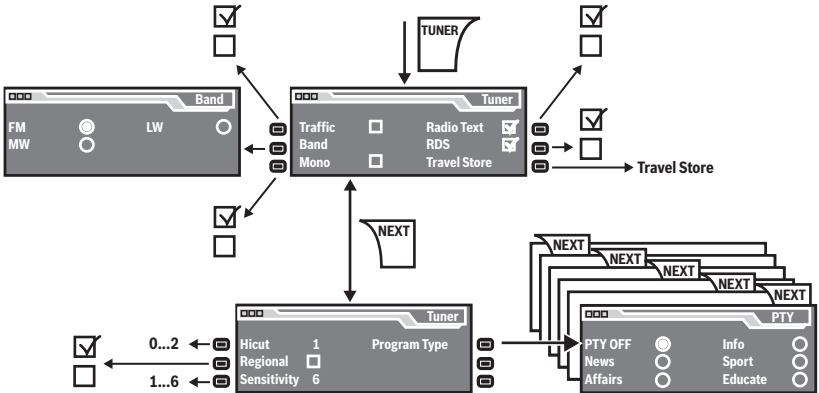

Changing the waveband (Band)

The tuner can receive FM, AM, and LW. To switch between these wavebands:

→ In the "Tuner" menu, select the "Band" menu item.

The "Band" menu appears.

→ Select the desired band.

- : This waveband is selected. The previously played station of this waveband is played back.

- : This waveband is not selected.

You can now do the following in this waveband:

- Searching stations (see page 85)
- Storing stations (see page 87)
- Calling up stored stations (see page 87)

Toggle between mono and stereo operation (Mono)

If you selected the "FM" waveband, you can toggle between mono and stereo operation.

- Press the softkey **9** in the "Tuner" menu (next to "Mono").
- : The mono operation is activated. Weak, noisy stations are played back more clearly.
 - : The stereo operation is activated. You are listening in stereo if the station broadcasts in stereo.

Note:

If you switch on the device, this setting is automatically set to stereo operation.

Switching the display of radio text on/off (Radio Text)

- Press the softkey **12** in the "Tuner" menu (next to "Radio Text").
- : The radio text display is switched on. Radio text is displayed on info line 3 **J** of the tuner display, provided that the station broadcasts radio text.
 - : The radio text display is switched off.

Allowing alternative frequencies (RDS)

The device can automatically switch to an alternative frequency (AF) of the same station if the reception becomes poor.

- Press the softkey **11** in the "Tuner" menu (next to "RDS").
- : The device automatically adjusts the best receivable frequency of the station, provided that the station supports the "AF" RDS function.
 - : The device does not change the frequency.

Searching FM stations automatically and storing them in the FMT memory bank (Travelstore)

You can automatically store the six FM stations offering the strongest reception in the region in the FMT memory bank.

- Press the softkey **10** in the "Tuner" menu (next to "Travelstore").
- "Travelstore" appears on the display. The tuner automatically searches for the six strongest FM stations and stores them in the FMT memory bank. After the storing is completed, the radio plays the station at memory location 1 of the FMT level.

Stations that were previously stored in the FMT memory bank are automatically deleted.

Activating/deactivating improved reception (Hicut)

The Hicut function improves reception during poor radio reception (for FM only).

- Change to the second page of the "Tuner" menu by pressing the **NEXT** button (6).
- Press the softkey (7) in the "Tuner" menu (next to "Hicut") several times.
 - "1": The Hicut function is switched on and has a low response sensitivity. If the reception is very poor, the interference level is automatically decreased.
 - "2": The Hicut function is switched on and has a high response sensitivity. If the reception is poor, the interference level is automatically decreased.
 - "0": The Hicut function is switched off.

Allowing/preventing automatic changing to other regional programmes (Regional)

Some stations divide their programmes into regional programmes with different contents at certain times. You can use the Regional function to prevent or allow the device from switching to alternative frequencies that are transmitting a different programme content.

- Change to the second page of the "Tuner" menu by pressing the **NEXT** button (6).
- Press the softkey (8) in the "Tuner" menu (next to "Regional").
 - : The Regional function is switched on. The tuner does not even switch to other regional programmes if the reception quality becomes poor.
 - : The Regional function is switched off. The tuner switches to other regional programmes if the reception of the current programme is too poor.

Changing the seek tuning sensitivity (Sensitivity)

The seek tuning sensitivity determines whether the automatic station seek tuning locates only strong stations or also weaker stations, which may be degraded by a high noise level.

- Change to the second page of the "Tuner" menu by pressing the **NEXT** button (6).
- Press the softkey (9) in the "Tuner" menu (next to "Sensitivity") several times.

The seek tuning sensitivity can be adjusted in six increments.

- "1": Low seek tuning sensitivity. During a station seek tuning (see page 85), only local strong stations are found.
- "6": High seek tuning sensitivity. Poor, remote stations are also found.

Restricting station seek tuning to certain programme contents (Program Type)

- Change to the second page of the "Tuner" menu by pressing the **NEXT** button (6).
- Press the softkey (12) in the "Tuner" menu (next to "Program Type").

- Scroll through the pages of the programme types with the **NEXT** button (6).
- Press the softkey next to the desired programme type.
- Next, start a station seek tuning (see page 85).

Traffic announcements (TA)

The device uses the RDS services TA and EON to play traffic announcements even if you are currently listening to another audio source. If you did not define a traffic information station, the device can automatically switch to a traffic information station of the same broadcasting network for the duration of a traffic announcement.

Receiving traffic announcements

As soon as the device receives a traffic announcement:

- The traffic announcement is switched through using the volume defined in the settings menu (see page 115),
- The traffic information display appears for the duration of the traffic announcement.

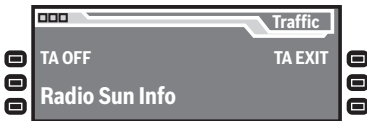

For the device to switch through traffic announcements:

- The priority of traffic announcements must be switched on (see page 93),

- A traffic information station must be set or it must belong to the same broadcasting network as the current station.

Skipping a traffic announcement

To cancel a traffic announcement without switching off the priority of traffic announcements:

- Press the softkey 12 (next to "TA EXIT").

The current traffic announcement is cancelled. The previously active audio source is played again and the corresponding display appears. If a traffic announcement is broadcast again, the device automatically switches it through again.

Permanently switching the priority of traffic announcements on/off

The TA symbol B appears on the display if the priority of traffic announcements is switched on and a traffic information station is set.

You have three options to switch the priority of traffic announcements on or off:

First option (traffic information display)

→ Press the softkey ⑦ (next to "TA OFF") during the traffic announcement.

The current traffic announcement is cancelled. The previously active audio source is played again and the corresponding display appears. If a traffic announcement is broadcast again, the device does **not** automatically switch it through.

Second option (TA on the display of the audio source)

→ Ensure that the display of the audio source is shown.

→ Press the softkey ⑨ (next to "TA").

The status is briefly displayed.

- "Traffic Info On": Traffic announcements are automatically switched through.
- "Traffic Info Off": Traffic announcements are **not** switched through.

Third option ("Traffic" in the "Tuner" menu)

→ Press the **TUNER** button ②.

The "Tuner" menu appears.

→ Press the softkey ⑦ (next to "Traffic").

- : Traffic announcements are automatically switched through.
- : Traffic announcements are **not** switched through.

Operating the integrated CD player

The device can play the following CD formats:

- CD audio (some CDs with copy protection cannot be played)
- CD-R or CD-RW with MP3 or WMA files (without DRM copy protection only)

Note:

The quality of self-burnt CDs fluctuates due to different CD blanks, CD burner software, and burn speeds. For this reason, it is possible that the device cannot play some self-burnt CDs.

If you cannot play a CD-R/CD-RW:

- Use blanks from a different manufacturer or a different colour,
- Burn CD-Rs at a lower speed.

What features do MP3 or WMA CDs have to have?

The device can only play and display MP3 or WMA CDs with the following features:

- The CD-ROM may contain only MP3 or only WMA files as well as folders, but no other files (including no CD audio files).
- CD format: ISO 9660 (Level 1 or 2) or Joliet

- Bit rate:
MP3: max. 320 kbit/s
WMA: max. 768 kbit/s
- File extension: Must be ".MP3" or ".WMA"
- ID3 tags: Version 1 or 2
- Max. 252 folders per CD with max. 999 MP3 files per folder (fewer in case of long file names: approx. 700 at 20 characters per file name)
- File names may not contain an umlaut or special character and may not be longer than 32 characters.
- WMA files with DRM (Digital Rights Management, copy protection/playback restriction) cannot be played! WMA files with DRM offered by music providers for download via the Internet cannot be played by the device. WMA files which you create yourself, e.g. from CD audio files, can be played.

Functions of the integrated CD player if an audio CD is inserted

After inserting an audio CD (see page 74) and selecting "CD" as the audio source for the first time (see page 77), "CD Reading" appears on the display. Next, the audio CD display appears (see also page 78). The playback starts .

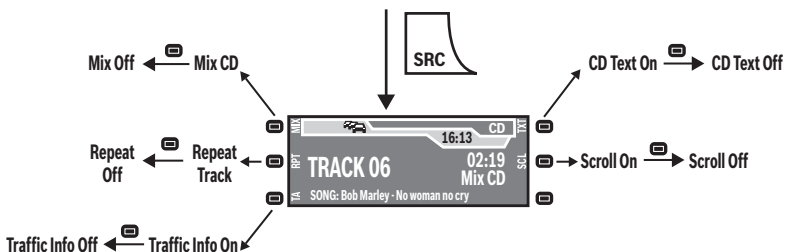

Menu item	Abbr.	Softkey	Setting option	See also
Random track play	MIX	⑦	Switch-on (Mix CD) Switch-off (Mix Off)	Page 81
Repeat title	RPT	⑧	Switch-on (Repeat Track) Switch-off (Repeat Off)	Page 82
Priority for traffic announcements	TA	⑨	Switch-on (Traffic Info On) Switch-off (Traffic Info Off)	Page 93
Display CD text	TXT	⑫	Switch-on (CD Text On) Switch-off (CD Text Off)	Page 97
Scrolling text	SCL	⑪	Switch-on (Scroll On) Switch-off (Scroll Off)	Page 97

Switching the CD text display on/off (TXT)

Some CDs support the display of text information about artist, album, track, etc.

To switch the display of CD text on/off:

→ Press the softkey  (next to "TXT").

The CD text status is briefly displayed.

- "CD Text On": The CD text is displayed on info line 3 .
- "CD Text Off": The CD text is not displayed.

Switching the scrolling text for CD text on/off (SCL)

The device can display CD text statically or as scrolling text (Scroll). To change the display of CD text:

→ Press the softkey  (next to "SCL").

The CD text display status is briefly displayed.

- "Scroll On": CD text is displayed as scrolling text, provided that the CD supports CD text, the display of CD text is switched on (see the previous section), and the CD text does not fit on info line 3  of the display.

- "Scroll Off": CD text is not displayed as scrolling text. If the CD text does not fit on info line 3  of the display, it appears incomplete.

Operating the MP3/WMA player

After inserting a medium with MP3 or WMA files (CD, MMC/SD card, or USB medium) (see pages 74 and 75) and selecting them as audio source for the first time (see page 77), "CD/MMC/USB Reading" appears on the display. Next, the MP3 display appears (see page 79). The playback starts.

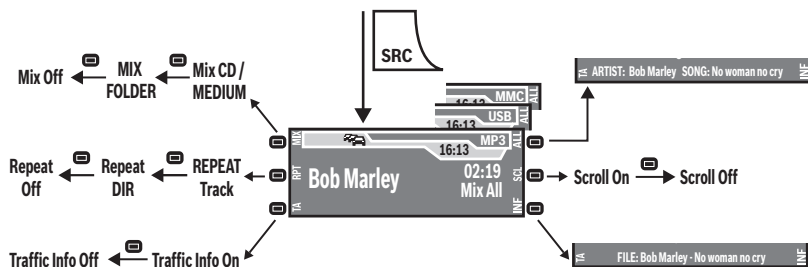

Menu item	Abbr.	Softkey	Setting option	See
Random track play	MIX	⑦	Playing files of the folder (Mix FOLDER) or data carrier (Mix CD or Mix MEDIUM) in random order Switch-off (Mix Off)	Page 81
Repeat title	RPT	⑧	Repeating the current file (Repeat Track) or files of the folder (REPEAT DIR) Switch-off (Repeat Off)	Page 82
Priority for traffic announcements	TA	⑨	Switch-on (Traffic Info On) Switch-off (Traffic Info Off)	Page 93
Showing infos	ALL	⑫	All available information for the current title scrolls once on info line 3 ⓵	Page 99
Scrolling text	SCL	⑪	Switch-on (Scroll On) Switch-off (Scroll Off)	Page 99
Selecting info	INF	⑩	Switching between DIR, SONG, ARTIST, ALBUM, and FILE	Page 99

Showing all the information of the current title (ALL)

To show all the available information about the current title (e.g. from ID3 tags) on the display:

→ Press the softkey **(12)** (next to "ALL").

All available information for the current title scrolls once on info line 3 **(J)**.

Switching scrolling text on/off (SCL)

The device can display the title information selected in the "INF" menu item (see next section), either statically or as scrolling text.

To toggle between static display and scrolling text:

→ Press the softkey **(11)** (next to "SCL").

- If the scrolling text display is switched on, the text scrolls without interruption from right to left on info line 3 **(J)**.
- If the scrolling text display is switched off, no more than the first 32 characters are displayed on the info line 3 **(J)**.

Selecting the title information to be displayed (INF)

The device can display the following title information on info line 3 **(J)**:

- Either information from embedded data or ID3 tags (artist, title, album, genre, year), if available
- Or file and folder name.

To select the title information to be displayed:

→ Press the softkey **(10)** repeatedly (next to "INF").

The type of information to be displayed is shown:

- "DIR": Name of the folder in which the currently playing file is located
- "SONG": Name of the current title
- "ARTIST": Name of artist
- "ALBUM": Name of album
- "FILE": File name of current title

Selecting a title from a list (Browser mode/playlist)

During the MP3 or WMA playback, you can always switch between the following modes using the **NEXT** button (6):

- MP3 display (left part of the figure),
- Browser mode (center part of the figure),
- Playlist mode (right part of the figure).

Note:

The device can play playlists that were created with an MP3 manager, such as WinAmp or Microsoft Media Player. These playlists must be present in the format M3U, PLS or RMP and stored in the root directory of the data carrier!

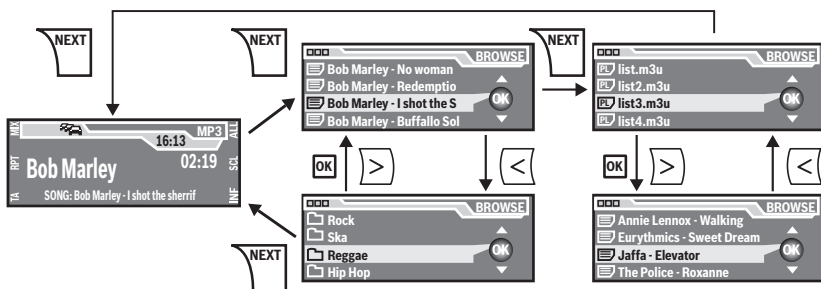

The browser mode or the playlist shows:

- The currently playing file at the top,
- the next three files to be played below it,
- two arrowheads that are highlighted if you can scroll in the corresponding direction.

Note:

The files are not played in alphabetical order, but in the order in which they were physically stored on the data carrier. This order is also displayed in the browser mode.

In the browser mode and the playlist mode, you can select files or folders from the list as follows:

- On the rocker switch (3), press $\bar{\Delta}$ or ∇ to scroll up or down.
- On the rocker switch (3), press < to change up to a higher-level folder.
- On the rocker switch (3), press > or press the **OK** button (17) to change up into a subfolder.
- On the rocker switch (3), press > or press the **OK** button (17) to play a selected file.

Operating the optional CD changer

After inserting at least one CD in the CD changer magazine and selecting "CDC" as the audio source for the first time (see page 77), "Magazine Scan" briefly appears on the display. The CD overview appears next. The playback starts.

You can toggle between the CD overview (top part of the figure) and the CD changer display (center part of the figure) by using the **NEXT** button (6).

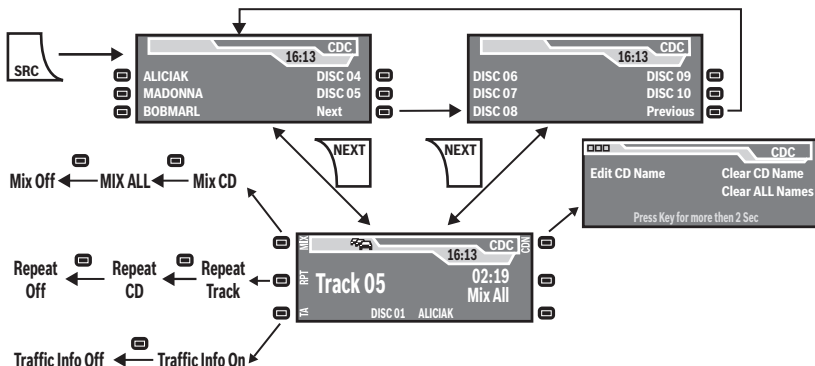

Menu item	Abbr.	Softkey	Setting option	See
Random track play	MIX	(7)	Playing all the titles of the CD (Mix CD) or the magazine (Mix ALL) in random order Switch-off (Mix Off)	Page 81
Repeat title	RPT	(8)	Repeating the current title (Repeat Track) or the current CD (Repeat CD) Switch-off (Repeat Off)	Page 82
Priority for traffic announcements	TA	(9)	Switch-on (Traffic Info On) Switch-off (Traffic Info Off)	Page 93
Editing CD names	CDN	(12)	Entering, changing, deleting names for CDs located in the changer magazine	Page 103

Selecting a CD from the CD magazine (CD overview)

The CD overview shows:

- either the CD number (e.g. "DISC 01")
- or the name of the CD (you can enter it as described in the following section)
- or an empty position if the corresponding position of the magazine is without a CD.

→ If necessary, press the **NEXT** button (6) to display the CD overview.

→ Press the softkey located next to the number or next to the name of the desired CD.

"Loading CD" appears briefly on the display. The playback starts next with the first track of the CD.

Note:

If there are more than five CDs in the magazine of your CD changer, press softkey (10), which is also located next to the menu items "Next" and "Previous", to toggle between the display of the first and last five CDs.

Changing the name of a CD in the magazine of the CD changer (CDN)

You can assign a name to every CD located in the CD changer. The name can have up to seven characters.

→ Select the CD to which you want to assign a name in the CD overview as described in the preceding section.

→ Press the **NEXT** button (6) to show the CD changer display.

→ Press the softkey (12) (next to "CDN").

→ Press the softkey (7) (next to "Edit CD Name").

The text input appears. The first character of the name is highlighted.

→ On the rocker switch (3), repeatedly press $\bar{\Delta}$ or ∇ to change the highlighted character.

→ On the rocker switch (3), press > to change to the next character.

→ Press the **OK** button (17) to finish the text input and to store the name entered.

Note:

To quit the text input without changing the name, press the **ESC** button (16).

Changing basic settings in the settings menu

To delete the name of the current CD:

- Press and hold the softkey ¹² (next to "Clear CD Name") for longer than two seconds. "Clearing" briefly appears on the display.

To delete the names of all the CDs located in the magazine of the CD changer:

- Press and hold the softkey ¹¹ (next to "Clear All Names") for longer than two seconds. "Clearing" briefly appears on the display.

Changing basic settings in the settings menu

The settings menu allows you to adjust basic device functions, such as sound, power-on volume or display brightness, to your specific needs.

To open the settings menu:

- Press the **MENU** button ¹⁵. The settings menu appears.

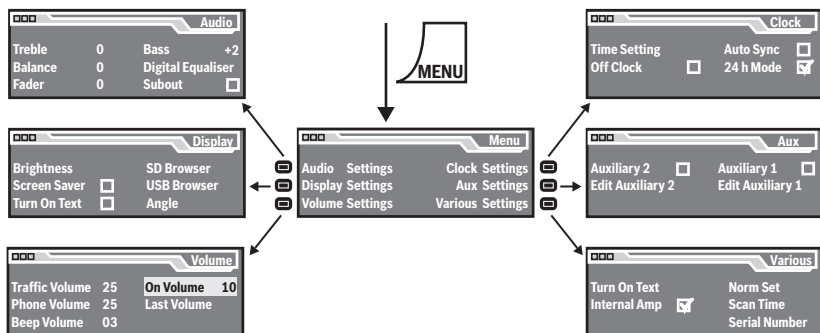

Adjusting sound and balance (Audio Settings)

The "Audio Settings" menu provides extensive possibilities for adjusting the sound to your specific needs.

→ Press the **MENU** button (15). The settings menu appears.

→ Press the softkey (7) (next to "Audio Settings").

The "Audio Settings" menu appears.

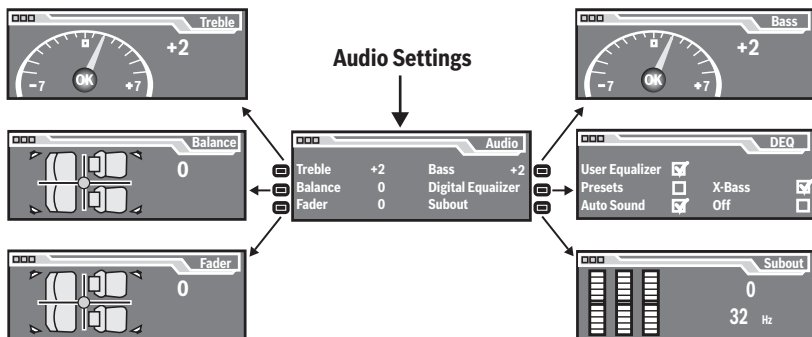

Changing treble or bass (Treble/Bass)

→ Press the softkey (7) (next to "Treble") or the softkey (12) (next to "Bass").

The corresponding sound control is displayed.

→ On the rocker switch (3), press $\bar{\wedge}$ or $\bar{>}$ to increase treble or bass.

→ On the rocker switch (3), press $\bar{\vee}$ or $\bar{<}$ to decrease treble or bass.

Changing the volume distribution (Balance/Fader)

The balance controls the volume distribution between left and right, the fader between front and rear.

→ Press the softkey (8) (next to "Balance") or softkey (9) (next to "Fader").

The volume distribution is displayed.

→ On the rocker switch (3), press on the desired direction.

The volume distribution changes. The display shows the new volume distribution.

Changing the equalizer setting (Digital Equalizer)

Your device features a digital 6-band equalizer. On the "Digital Equalizer" menu, you can adjust the sound to your vehicle and your specific needs and eliminate problems, such as droning or poor voice comprehension.

- Press the **MENU** button (15). The settings menu appears.
- Press the softkey (7) (next to "Audio Settings"). The "Audio Settings" menu appears.
- Press the softkey (11) (next to "Digital Equalizer").

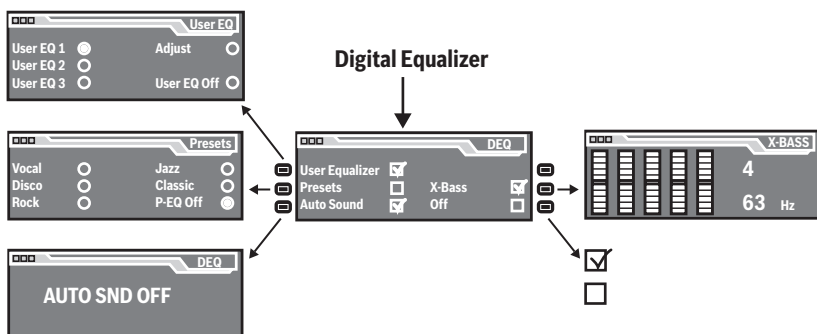

Calling up a user-defined equalizer setting (User Equalizer)

In the "User Equalizer" menu, you can create, store and call up to three user-defined equalizer settings ("User EQ 1 to 3").

- Press the softkey (7) (next to "User Equalizer").
The "User EQ" menu appears.
- Press one of the three softkeys (7) to (9) (next to "User EQ 1", "User EQ 2" or "User EQ 3").

- : The corresponding user-defined equalizer setting is selected. The sound changes accordingly.
- : The corresponding user-defined equalizer setting is not selected.

- Press the softkey (10) (next to "User EQ Off") to switch off the equalizer.

Creating/changing a user-defined equalizer setting (Adjust)

You can adjust the three different user-defined equalizer settings to different situations, e.g. for the driver alone, for driver and passenger or for passengers in the front and the rear.

- Select the user-defined equalizer setting which you want to create/change as described in the preceding section.
- Press the softkey $\text{\textcircled{12}}$ (next to "Adjust"). The "User EQ 1/2/3" menu opens.

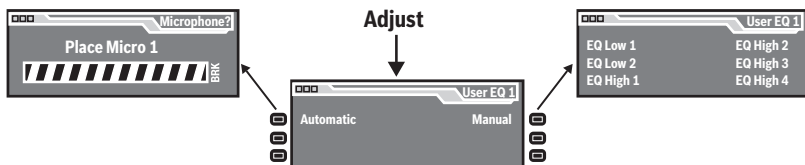

Automatic:

You can automatically create **one** of the three equalizer settings using a measurement microphone (available as an accessory).

Before starting, ensure the following:

- The measurement microphone must be connected before installing the device as described in the installation instructions of the measurement microphone.
 - There must be true silence during the measurement since external noise falsify the measurement. For this reason, close all windows, doors, and the sliding sunroof. Switch off the engine, but leave the ignition switched on.
- The temperature inside the vehicle must be below 55 °C.
 - All the loudspeakers must be connected. The sound radiating from the loudspeakers must not be obstructed by any objects.

- Position the measurement microphone
 - for the driver only – 10 cm next to the right ear of the driver,
 - for driver and passenger – exactly between both at the head level,
 - for passengers in the front and rear – at the head level in the center of the vehicle.

- Ensure that all passengers in the vehicle are sitting and remaining quiet.
- Change to the "User Equalizer" menu and call up one of the user-defined equalizer settings ("User EQ 1 to 3") as described in the preceding section.
- Open the "User EQ 1/2/3" menu as described on page 107.
- Press the softkey **7** (next to "Automatic") and follow the instructions on the display.
After a 5-second countdown, you hear the test noise and the display intermittently shows "Silence Please" and "Adjusting".

The automatic equalizer setting finishes successfully if the display shows "Adjustment OK". The equalizer setting is saved. Any previously stored setting under this equalizer setting is overwritten. The new setting can now be called up under the corresponding equalizer setting ("User EQ 1 to 3").

Manual:

As an alternative, you can manually create the equalizer setting without measurement microphone. In each of the six frequency bands, you can select one specific individual centre frequency and finely adjust its level and quality factor Q.

- Insert a CD with which you are very familiar.
- Adjust bass, treble, balance, and fader to zero.
- Open the "User EQ 1/2/3" menu as described on page 107.
- Press the softkey **12** (next to "Manual").
- First, select a frequency band to be changed. First, change the centre, then the treble, followed by the bass.
 - "EQ Low 1" to "2": To change the bass (20 to 250 Hz).
 - "EQ High 1" to "4": To change the centre or treble (320 to 20,000 Hz).

The frequency spectrum is displayed. If you already changed the level in another frequency band, this change is visible in the frequency spectrum.

The current centre frequency (Hz) is highlighted.

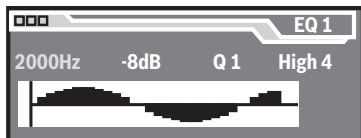

- Select the centre frequency to be changed by pressing on $\bar{\wedge}$ or $\bar{\vee}$ on the rocker switch (3).

In the two frequency bands "EQ Low 1" and "2", you can select one centre frequency each from 20 to 250 Hz.

In the four frequency bands "EQ High 1" to "4", you can select one centre frequency each from 320 to 20,000 Hz.

- On the rocker switch (3), press >.

The level display (dB) is highlighted.

- Select the level of the previously set centre frequency by pressing on $\bar{\wedge}$ or $\bar{\vee}$ on the rocker switch (3).

The level change is displayed in the frequency spectrum. The sound changes accordingly.

- On the rocker switch (3), press >.

The quality factor Q is highlighted.

- Select the desired quality factor Q by pressing on $\bar{\wedge}$ or $\bar{\vee}$ on the rocker switch (3).

- "Q1": Low edge steepness, wide filter bandwidth
- "Q2": Medium edge steepness and filter bandwidth
- "Q3": High edge steepness, narrow filter bandwidth

The change is displayed in the frequency spectrum. The sound changes accordingly.

- Press the OK button (17).



Your user-defined equalizer setting is saved.

Which equalizer setting is the correct one?

Sound impression or problem	Measure	
	Centre frequency (Hz)	Level (dB)
Unclean bass, droning, unpleasant pressure	125–400	approx. -4
Very transparent, aggressive sound, no stereo effect	1000–2500	approx. -4 to -6
Muffled sound, low transparency, instruments do not excel	8000–12500	approx. +4 to +6
Insufficient bass	50–100	approx. +4 to +6

Selecting a sound preset (Presets)

This menu item allows you to select one of the following sound presets: Vocal, Disco, Rock, Jazz, or Classic.

- Press the softkey located next to the desired sound preset.
 - : The sound preset is selected.
 - : The sound preset is not selected.

Setting the speed-dependent volume increase (Auto Sound)

When you are driving faster, the device can automatically increase the volume to compensate for the driving noise. In order for this to work, the speedometer signal must be connected as described in the installation instructions. You can adjust this volume increase from 0 (no increase) to 5 (maximum increase).

- Press the softkey  (next to "Auto Sound").

The "Auto Sound" menu appears.

Note:

If no increase is set, the display shows "AUTO SND OFF".

→ On the rocker switch , press $\bar{\wedge}$ or $>$ to raise the volume increase.

→ On the rocker switch , press $\underline{\vee}$ or $<$ to lower the volume increase.

Setting the bass increase (X-Bass)

X-bass is a bass increase at low volume. This bass increase can be set in increments from 0 (no increase) to 6 (maximum increase) for the following frequencies: 32 Hz, 40 Hz, 50 Hz, 63 Hz, or 80 Hz.

→ Press the softkey  (next to "X-Bass").

The individual frequencies are displayed as bars and the bass increase as bar segment.

→ On the rocker switch , press $<$ or $>$ to select the desired frequency.

→ On the rocker switch , press $\bar{\wedge}$ or $\underline{\vee}$ to set the desired bass increase.

Switching off the equalizer

→ Press the softkey  in the "Digital Equalizer" menu (next to "Off").

Configuring the preamplifier output for the subwoofer (Subout)

If you want to use an additional subwoofer, it can be adjusted to the other loudspeakers.

You can adjust the level of the Subout preamplifier output in 13 increments from -6 dB (maximum decrease) to +6 dB (maximum increase) for one of the following cut-off frequencies: 80 Hz, 120 Hz, or 160 Hz.

→ Press the softkey $\text{\textcircled{10}}$ in the "Audio Settings" menu (next to "Subout").

The "Subout" menu appears.

→ On the rocker switch $\text{\textcircled{3}}$, press < or > to select the desired cut-off frequency.

→ On the rocker switch $\text{\textcircled{3}}$, press $\bar{\Delta}$ or ∇ to set the desired level of the preamplifier output.

Changing display settings (Display Settings)

In the "Display Settings" menu, you can adjust the display brightness and the display contrast, among other things.

→ Press the **MENU** button (15). The settings menu appears.

→ Press the softkey (8) (next to "Display Settings").

The "Display" menu appears.

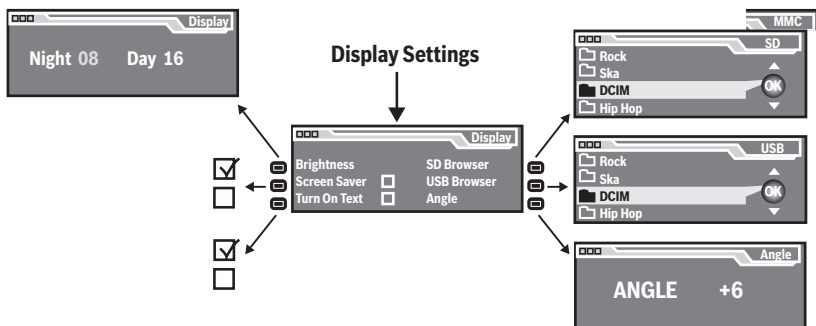

Changing the brightness of the display for day/night (Brightness)

See page 83.

Activating/deactivating the screen saver (Screen Saver)

The screen saver can be called up only if you activate the display of the screen saver here.

→ Press the softkey (8) (next to "Screen Saver").

- : You can call up the screen saver instead of the display of the audio source by pressing the **ESC** button (16).

Press any button to deactivate the screen saver and show the display of the active audio source again.

- : The screen saver **cannot** be called up.

Switching the welcome text on/off (Turn On Text)

After switch-on, the display shows a brief animation. A welcome text can be shown next. This text is factory set to "The advantage in your car!"

→ Press the softkey **9** (next to "Turn On Text").

- : The welcome text is shown after switch-on.
- : The welcome text is not shown.

To change the welcome text, see "Changing the welcome text (Turn On Text)" on page 120.

Changing images and animations (SD Browser/USB Browser)

You can replace the following factory installed images and animations with your own:

- the wallpaper which appears when "AUX" is selected as audio source (the image is set to a connector at the factory),
- the screen saver,
- the wallpaper which appears if the radio is switched off and the vehicle ignition is switched on, and also the "Off Clock" menu item in the "Clock Settings" menu as described on page 117. The image is set to an analogue clock at the factory.

For your images and animations to be displayed, they must be created using the BMP file format. For the images to be displayed without distortion, they should ideally have 270 x 96 pixels.

Animations consist of max. 20 BMP files that are automatically displayed in succession just like single frames of a movie. All BMP files of an animation must be stored in a separate folder. No other files may be stored in this folder!

The images must be available as a file on an MMC/SD card or USB medium. The MMC/SD card must be inserted or the USB medium must be connected.

→ Press the softkey **12** (next to "SD Browser") if the images are available on an MMC/SD card.

Press the softkey **11** (next to "USB Browser") if the images are available on a USB medium.

The file browser opens.

You can select a BMP file or a folder from the list as follows:

→ On the rocker switch **3**, press $\bar{\Delta}$ or ∇ to scroll up or down.

→ On the rocker switch **3**, press $<$ to change up to a higher-level folder.

→ On the rocker switch **3**, press $>$ to change down to a subfolder.

→ Press the **OK** button **17** to select the selected file or the

selected folder with the BMP files of the animation.

The "Picture Download" menu appears.

- Press the softkey next to the image or the animation to be replaced.
 - "Clock" replaces the wallpaper which appears if the radio is switched off and the vehicle ignition is switched on,
 - "Minimal Mode" replaces the screen saver,
 - "Aux" replaces the wallpaper which appears if "AUX" is selected as audio source.

A progress bar illustrates the transfer of the file. As soon as the file has been transferred, the display of the active audio source appears. Your image or animation now replaces the factory setting.

Adjusting the display viewing angle (Angle)

The angle at which the driver looks at the display is dependent upon, among other things, the installation position of the device, the seating position, and the physical size of the driver. You can adjust the display contrast to your viewing angle as follows.

- Press the softkey $\text{\textcircled{10}}$ (next to "Angle").

The "Angle" menu opens and the current display contrast is shown.

- On the rocker switch $\text{\textcircled{3}}$, press $\bar{\wedge}$ or $\bar{>}$ to increase the display contrast.
- On the rocker switch $\text{\textcircled{3}}$, press $\bar{\vee}$ or $\bar{<}$ to decrease the display contrast.

You can adjust the display contrast in 13 increments from -6 to +6.

Changing volume presets (Volume Settings)

In the "Volume Settings" menu, select the volume presets for traffic announcements, the telephone, the signal tones, etc.

→ Press the **MENU** button (15). The settings menu appears.

→ Press the softkey (9) (next to "Volume Settings").

The "Volume Settings" menu appears. The volume presets are displayed as two-digit numbers. One of the two menu items "On Volume" or "Last Volume" is highlighted.

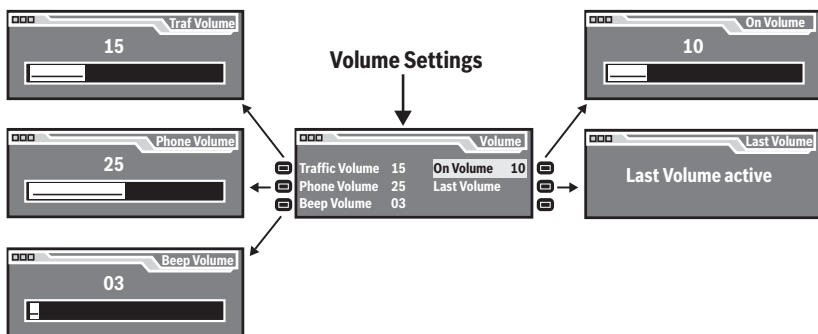

Changing the volume presetting of traffic announcements (Traffic Volume)

If the device puts a traffic announcement through, you hear it at the preset volume.

→ Press the softkey (7) (next to "Traffic Volume").

The volume presetting for traffic announcements appears.

→ Adjust the desired volume using the volume control (5) or the rocker switch (3) (increments 1 to 50).

If a traffic announcement is broadcast, the device automatically puts it through at this volume. During the traffic announcement, you can always change the volume by means of the volume control (5).

Changing the volume presetting of the telephone (Phone Volume)

If the device puts a phone call through, it always starts at the preset volume.

→ Press the softkey (8) (next to "Phone Volume").

The volume presetting for phone calls appears.

- Adjust the desired volume using the volume control ⑤ or the rocker switch ③ (increments 1 to 50).

During the phone call, you can always change the volume by means of the volume control ⑤.

Changing the volume presetting of the signal tone (Beep Volume)

If a signal tone sounds, you always hear it at the preset volume.

- Press the softkey ⑨ (next to "Beep Volume").

The volume presetting for the signal tone appears.

- Adjust the desired volume using the volume control ⑤ or the rocker switch ③ (increments 0 to 6).

You hear a signal tone at the selected volume.

- If you do not want to hear any signal tones, set the volume to zero.

"BEEP OFF" appears on the display.

Changing the presetting of the power-on volume (On Volume)

You can configure the device so that the playback after switch-on always starts with the volume set here. For this purpose, the

"On Volume" menu item must be highlighted.

- Press the softkey ⑫ (next to "On Volume").

The presetting for the power-on volume appears.

- Adjust the desired volume using the volume control ⑤ or the rocker switch ③ (increments 1 to 50).

If you open the "Volume Settings" menu again, the "On Volume" menu item is highlighted.

Restoring the volume at switch-on (Last Volume)

You can configure the device so that the playback after switch-on always starts with the previously selected volume. For this purpose, the "Last Volume" menu item must be highlighted.

- Press the softkey ⑪ (next to "Last Volume").

"Last Volume active" briefly appears on the display. If you open the "Volume Settings" menu again, the "Last Volume" menu item is highlighted.

Changing clock settings (Clock Settings)

In the "Clock Settings" menu, you can set the clock of the device as well as change the display options of the clock.

→ Press the **MENU** button (15). The settings menu appears.

→ Press the softkey (12) (next to "Clock Settings").

The "Clock" menu appears.

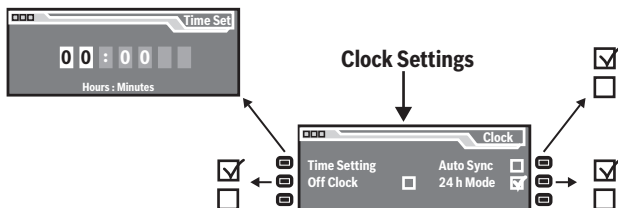

Setting the time (Time Setting)

→ Press the softkey (7) (next to "Time Setting").

The currently set time appears.
The hours are highlighted.

→ On the rocker switch (3), press $\bar{\Delta}$ or ∇ to change the hours.

→ On the rocker switch (3), press \triangleright to change to the minutes.

→ On the rocker switch (3), press $\bar{\Delta}$ or ∇ to change the minutes.

→ Press the **OK** button (17) to finish the input and to save the time.

Note:

To quit the input without changing the time, press the **ESC** button (16).

Switching the time display on/off with switched-off device (Off Clock)

The time can be displayed while the device is switched off, if the vehicle ignition is switched on. To switch this time display on/off:

→ Press the softkey (8) (next to "Off Clock").

- : The time display is switched on.
- : The time display is switched off.

Switching the RDS synchronisation of the clock on/off (Auto Sync)

The clock can automatically be synchronised with the RDS time signal, provided that a station is set that broadcasts this RDS time signal.

- Press the softkey **(12)** (next to "Auto Sync").
 - : The synchronisation is switched on.
 - : The synchronisation is switched off.

Switching the 24-hour time display on/off (24 h Mode)

The time can be displayed using the 12-hour or 24-hour format. To switch between these two formats:

- Press the softkey **(11)** (next to "24 h Mode").
 - : The 24-hour format is switched on.
 - : The 12-hour format (AM/PM) is switched on.

Configuring audio inputs (Aux Settings)

Up to two external audio source, such as MiniDisc player or external MP3 player, can be connected to the audio inputs "Auxiliary 1" and "Auxiliary 2". If you are connecting a CD changer, it occupies audio input "Auxiliary 1" and you can also connect "Auxiliary 2".

The audio sources "Auxiliary 1" and "Auxiliary 2" **cannot** be operated using the Memphis. Only the volume can be changed.

- Press the **MENU** button **(15)**. The settings menu appears.
- Press the softkey **(11)** (next to "Aux Settings").

The "Aux" menu appears. The audio input "Auxiliary 1" is displayed only if no CD changer is connected.

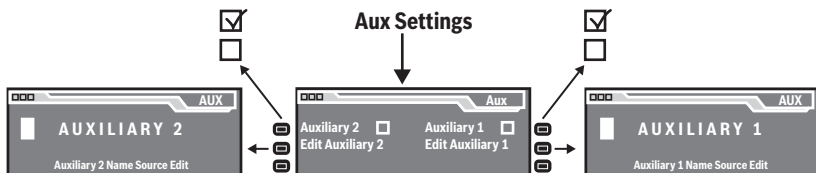

Activating/deactivating audio inputs (Auxiliary 1/2)

Audio inputs, to which you are connecting external audio sources, must be activated as follows.

→ Press the softkey **(12)** (next to "Auxiliary 1") and/or the softkey **(7)** (next to "Auxiliary 2").

The status of the audio input is displayed:

- : The corresponding audio input is activated and can be selected as audio source using the **SRC Taste (18)**.
- : The corresponding audio input is deactivated. It cannot even be selected as audio source if an external audio source is connected.

Renaming audio inputs (Edit Auxiliary 1/2)

If you select an audio input as audio source, "Auxiliary 1" or "Auxiliary 2" appears on the display. To change this name:

→ Press the softkey **(11)** (next to "Edit Auxiliary 1") and/or the softkey **(8)** (next to "Edit Auxiliary 2").

The text input appears. The first character of the name is highlighted.

→ On the rocker switch **(3)**, repeatedly press **↵** or **↶** to change the highlighted character.

→ On the rocker switch **(3)**, press **>** to change to the next character. The name can have up to 16 characters.

→ Press the **OK** button **(17)** to finish the text input and to store the name entered.

Note:

To quit the text input without changing the name, press the **ESC** button **(16)**.

Changing special settings (Various Settings)

In the "Various Settings" menu, you can change the scan time for the scan function and the welcome text.

- Press the **MENU** button (15). The settings menu appears.
- Press the softkey (10) located next to the "Various Settings" menu item.

The "Various Settings" menu appears.

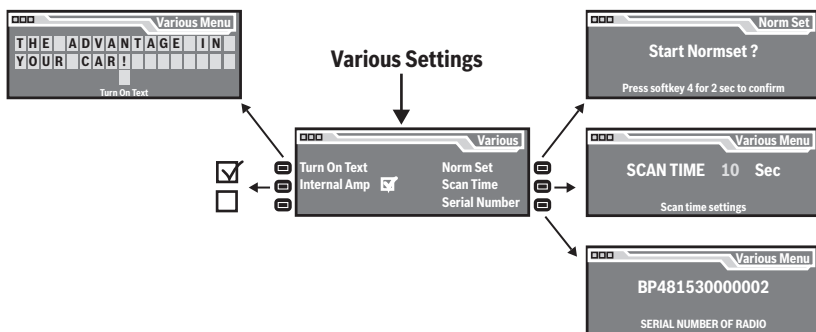

Changing the welcome text (Turn On Text)

When you switch on the device, a welcome text appears. This text is factory set to "The advantage in your car!" To change this text:

- Press the softkey (7) (next to "Turn On Text").

The text input appears. The first character of the welcome text is highlighted.

- On the rocker switch (3), repeatedly press $\bar{\text{A}}$ or $\underline{\text{A}}$ to change the highlighted character.

- On the rocker switch (3), press > to change to the next character. The welcome text can have up to 35 characters.
- Press the **OK** button (17) to finish the text input and to store the welcome text entered.

Note:

To quit the text input without changing the welcome text, press the **ESC** button (16).

Switching the internal amplifier on/off (Internal Amp)

If you connected the device to an external power amplifier via the preamplifier outputs (Preamp), you can switch off the internal amplifier of the device as follows:



CAUTION!

No sound with switched-off internal amplifier!

If you switch off the internal amplifier, you do not hear a sound from the loudspeakers connected to the device!

→ Switch off the internal amplifier only if you connected an external power amplifier to the preamplifier outputs (Preamp) of the device and you connected your loudspeakers to this power amplifier:

→ Press the softkey **8** (next to "Internal Amp").

The status of the internal amplifier is displayed:

- : The internal amplifier is switched on. Loudspeakers connected to the device play back the selected audio source.

- : The internal amplifier is switched off. Loudspeakers connected to the device always remain mute. The loudspeakers must be connected to the external amplifier.

Resetting the device to factory settings (Norm Set)

→ Press the softkey **12** (next to "Norm Set").

The "Norm Set" menu appears.

→ Press and hold the softkey **12** for approx. two seconds.

"NORMSET ON" briefly appears on the display. The device is reset to the factory settings. Images and animations, which you transferred to the device, are deleted.

Note:

To exit the "Norm Set" menu without resetting the device to the factory settings, press the **OK** button **17** or the **ESC** button **16**.

Changing the scan time (Scan Time)

→ Press the softkey **11** (next to "Scan Time").

The current scan time is displayed.

Error table

- On the rocker switch (3), repeatedly press $\bar{\Delta}$ or $>$ to increase the scan time.
- On the rocker switch (3), repeatedly press ∇ or $<$ to decrease the scan time.

You can adjust scan times in increments of 5 seconds from 5 to 30 seconds.

Displaying the serial number (Serial Number)

Every device has a separate serial number. To display this number:

- Press the softkey (10) (next to "Serial Number").

The serial number is displayed.

Error table

If the device does not function properly, switch the device off and on again.

If problems still persist, you can easily correct the following problems.

Problem	Possible cause	Possible remedy
The menus do not appear as shown in these instructions. The tuner cannot be adjusted to the frequencies listed in the technical data.	The device is not set to your region.	Set the device to your region as described on page 88.
The display shows information about the device.	The demo mode is activated.	Press and hold the MENU button (15) for four seconds.
The device is always silent, even though it is correctly connected.	The internal amplifier is switched off.	Switch on the internal amplifier as described on page 121.

If problems still persist, please contact an authorised workshop or the Blaupunkt customer service (see the last page).

Specifications

Weight	approx. 1.5 kg
Voltage supply Operating voltage:	10.5–14.4 V
Current consumption In operation: 10 seconds after switch-off:	max. 10 A < 3.5 mA
Amplifier output power acc. to DIN 45324: at 14.4 V: max. power:	4 x 25 W sine 4 x 45 W at 14.4 V
Preamplifier output (Preamp Out) 4 channels:	3 V
Input sensitivity AUX inputs: Telephone input:	2 V / 6 k Ω 10 V / 1 k Ω
Tuner FM waveband: AM waveband: LW waveband: FM frequency response:	87.5–108 MHz 531–1602 kHz 153–279 kHz 35–16,000 Hz
CD player Frequency response:	20–20,000 Hz
Subject to technical changes!	

Glossary

AF – Alternative frequency

The range of FM stations is limited. For this reason, FM programmes are distributed to different frequencies. The AF RDS service sends these frequencies to the tuner. If the reception deteriorates because the vehicle leaves the reception area of a frequency, the tuner can automatically change to the best receivable frequency.

DEQmaxEx – Digital parametric equalizer with variable filter quality

This function allows for a maximum of exact frequency optimisation, so that the sound spectrum can be adjusted to the vehicle or your individual taste.

EON – Enhanced Other Network

In case of a traffic announcement (TA), the device switches from a non-traffic information station to a traffic information station of the same broadcasting network (e.g. from NDR 3 to NDR 2). After the traffic announcement, the system switches back to the previously heard programme.

Quality factor Q

It determines the filter quality of the equalizer, i.e. the edge steepness and filter bandwidth, dependent upon the characteristic frequency.

ID3 tags

ID3 tags contain additional information for MP3 files (e.g. artist, title, album, genre, year).

Mass storage device

Format for storage media that can permanently store large amounts of data, such as USB removable storage devices (USB stick or USB hard disk).

MMC/SD card (Multimedia Card/ Secure Digital Card)

MMC/SD cards are memory card formats that can be inserted in card slot (20) of the device. The device can play MP3 and WMA files stored on the memory cards.

MP3, WMA

MP3 and WMA are audio data formats that allow for high compression with little loss in quality.

Playlist

Playback list for MP3 or WMA files In playlists, you determine the order in which certain titles should be played.

They are created with an MP3 manager, such as WinAmp or Windows Media Player.

PTY – Program Type

The device searches only for stations with preselectable programme content (e.g. news, rock, pop, sports, etc.)

PTY 31

The car sound system automatically switches through emergency and disaster announcements.

RDS – Radio Data System

RDS is a service of the radio stations. Besides the conventional music and voice contributions, additional information is broadcast in the form of encrypted digital signals which can be analysed by the car sound system.

Note:

The RDS services are not supported by all radio stations!

REG – Regional

Activating the regional service (REG ON) prevents switching over to a frequency with better reception of the adjacent regional programme. This allows for continuously a regional programme even in peripheral regions. The disadvantage is that the station may not be received without interferences.

Root directory

Main directory of a data carrier. The root directory contains all other directories.

Subwoofer, Subout

Separate low-bass loudspeaker. The device has a Subout preamplifier output. You can connect either an active subwoofer or a separate power amplifier with subwoofer.

TA – Traffic Announcement

The car sound system switches traffic announcements through, even if you are currently listening to other sources (e.g. CD, AUX) or the radio is muted.

TMC – Traffic Message Channel

RDS data service for area-based traffic announcements. Digital traffic information data channel with continuously updated data about the traffic situation. TMC receivers allow for a selection of the data flow with respect to direction of travel, area or type of street. With a push of a button, you have access to the most current tailor-made information at all times.

Your device has a TMC output, which you can use for connecting Blaupunkt navigation systems. Please contact your authorised Blaupunkt dealer for additional information.

T-STORE – Travelstore

Automatic searching and storing of the six strongest radio stations received of the region.

Tuner

Receiving unit of the radio.

USB – Universal Serial Bus

USB is an interface for connecting external removable storage devices to the car sound system.

X-BASS

X-BASS allows for boosting the bass at low volume levels (loudness). This renders the sound more natural even at a low volume.

Index

Symbole

24 h MODE **118**

A

ADJUST **107**

ALL **99**

Alternative frequencies

Allowing **90**

Amplifier **121**

AREA **88**

Audio inputs

Activating **119**

Configuring **118**

Renaming **119**

AUDIO SETTINGS **105**

Audio source **77**

Tuner **85**

AUTOMATIC **107**

AUTO SOUND **110**

AUTO SYNC **118**

AUXILIARY **119**

AUX SETTINGS **118**

B

BALANCE **105**

Band **89**

BAND button **72, 83**

BASS **105**

Bass increase **110**

BEEP VOLUME **116**

Browser **100**

Button for detaching the control panel

72

Buttons **72**

Button to eject/insert a CD **72**

C

CD

Changing the name of a CD in the

CD changer magazine **103**

inserting **74**

removing **74**

Selecting from the CD changer

magazine **102**

CD changer **102**

Changing the name of a CD in the

magazine **103**

Display **79**

Functions **102**

CD changer display **79**

CD display **78**

CD overview **103**

CD player **95**

Display **78**

Functions **96**

CD text **97**

Clock **117**

24-hour time display **118**

Display with switched-off device

117

Setting **117**

Synchronise with RDS **118**

CLOCK SETTINGS **117**

Control panel **73**

Correcting errors **122**

Correcting malfunctions **122**

Country code **88**

D

DIGITAL EQUALISER **106**

Display

Animation **113**

Brightness **83**

Images **113**

Viewing angle **114**

DISPLAY SETTINGS **112**

Note:

Keywords in capital letters refer to menu items.

- E**
 - EDIT AUXILIARY **119**
 - EQUALISER **106, 110**
 - Calling up a user-defined setting **106**
 - Creating a user-defined setting **107**
 - Settings recommendations **109**
 - ESC button **73, 83**
- F**
 - Factory settings **121**
 - FADER **105**
 - FM1, FM2, FM3, and FMT **85**
 - Forward **80**
- H**
 - HICUT **91**
 - High Cut **91**
- I**
 - Improved reception **91**
 - INF **99**
 - INTERNAL AMP **121**
- L**
 - LAST VOLUME **116**
- M**
 - MANUAL **108**
 - Memory bank **85**
 - Memory card
 - inserting **75**
 - removing **75**
 - Menu
 - Calling **83**
 - Changing and saving settings **84**
 - Exiting **84**
 - Operate **82**
 - Operating example **83**
 - Settings menu **104**
 - Tuner **89**
 - MENU button **73, 83**
 - MIX **81**
 - MMC card: *see* Memory card
 - MONO **90**
 - Mono operation **90**
 - MP3
 - Files on CD **95**
 - MP3 display **79**
 - MP3 player **98**
 - Display **79**
 - Functions **98**
 - Muting **76**
- N**
 - NEXT button **72, 83**
 - NORM SET **121**
- O**
 - OFF CLOCK **117**
 - OK button **73, 80, 83**
 - On/Off button **72**
 - ON VOLUME **116**
- P**
 - PHONE VOLUME **115**
 - Playlist **100**
 - PRESETS **110**
 - PROGRAM TYPE **92**
 - PTY **92**
- R**
 - RADIO TEXT **90**
 - Radiotext **90**
 - Random track play **81**
 - RDS **90**
 - Receiving a regional programme **91**
 - Region
 - Adjust **88**
 - REGIONAL **91**
 - Repeat **81**
 - Repeat mode **81**
 - Repeat title **82**
 - Reverse **80**
 - Rocker switch **72, 80**
 - RPT **81, 82**
- S**
 - Safety **70**
 - SCAN **82**

SCAN TIME **121**
Scan time **121**
SCL **97, 99**
SCREEN SAVER **112**
Screen saver **112**
SD BROWSER **113**
SD card: *see* Memory card
Seek tuning sensitivity **92**
SENSITIVITY **92**
SERIAL NUMBER **122**
Serial number **122**
Settings menu **104**
Skip title **80**
Softkey **72, 80**
Sound **105**
 Presetting **109**
SRC button **73**
Station
 Calling **87**
 Scanning **87**
 Searching **85**
 Storing **87**
Stereo operation **90**
SUBOUT **111**
Subwoofer **111**
Switch-off **74**
Switch-on **74**

T
TA **81**
Telephone **76**
TIME SETTING **117**
Title information **99**
Traffic announcements **81, 93**
 Switching the priority on/off **93**
TRAFFIC VOLUME **115**
Travelstore **90**
TREBLE **105**
Tuner
 Display **78**
Tuner display **78**
TURN ON TEXT **112, 120**
TXT **97**

U
USB BROWSER **113**
USB stick
 connecting **75**
USER EQUALISER **106**

V
VARIOUS SETTINGS **120**
Volume **76**
 At switch-on **116**
 Muting **76**
 Presetting **115**
 Speed-dependent increase **110**
Volume control **72**
Volume distribution **105**
VOLUME SETTINGS **115**

W
Warranty **71**
Waveband **89**
Welcome text **112, 120**
WMA
 Files on CD **95**
WMA player **98**
 Functions **98**

X
X-BASS **110**

D Einbauanleitung



Sicherheitshinweise

Für die Dauer der Montage und des Anschlusses beachten Sie bitte folgende Sicherheitshinweise.

- Minuspol der Batterie abklemmen! Dabei die Sicherheitshinweise des Kfz- Herstellers beachten.
- Beim Bohren von Löchern darauf achten, dass keine Fahrzeugteile beschädigt werden.
- Der Querschnitt des Plus- und Minuskabels darf 1,5 mm² nicht unterschreiten.
- **Fahrzeugeitige Stecker nicht an das Radio anschließen!**
- Die für Ihren Fahrzeugtyp erforderlichen Adapterkabel erhalten Sie im BLAUPUNKT-Fachhandel.
- Je nach Bauart kann Ihr Fahrzeug von dieser Beschreibung abweichen. Für Schäden durch Einbau- oder Anschlussfehler und für Folgeschäden übernehmen wir keine Haftung.

Sollten die hier aufgeführten Hinweise für Ihren Einbau nicht passen, so wenden Sie sich bitte an Ihren Blaupunkt-Fachhändler, Ihren Fahrzeughersteller oder unsere Telefon-Hotline.

Bei Einbau eines Amplifier oder Changers müssen unbedingt erst die Gerätemassen angeschlossen werden,

bevor die Stecker für die Line-In- oder Line-Out-Buchse kontaktiert werden.

Fremdgerätemassen dürfen nicht an der Autoradiomasse (Gehäuse) angeschlossen werden.

GB Installation instructions



Safety instructions

When carrying out installation work and making connections please observe the following safety instructions:

- Disconnect the negative terminal of the battery! When doing so, please observe the vehicle manufacturer's safety instructions.
- Make sure you do not damage vehicle components when drilling any holes.
- The cross sections of the positive and negative cables must not be less than 1.5 mm².
- **Do not connect the vehicle's plug connectors to the radio!**
- You can obtain the adapter cable required for your vehicle type from any BLAUPUNKT dealer.
- Depending on the model, your vehicle may differ from the description provided here. We accept no responsibility for any damages due to incorrect installation or connection or for any consequential damages.

If the information provided here is not suitable for your specific installation requirements, please contact your Blaupunkt dealer, your vehicle manufacturer or our telephone hotline.

When installing an amplifier or changer, you must first connect the device earth connections before connecting the plugs for the line-in or line-out jacks.

Earth connection of external devices may not be connected to earth of car sound system (housing).

F Notice de montage



Consignes de sécurité

Respecter les consignes de sécurité suivantes pendant la durée du montage et du branchement.

- Débrancher le pôle (-) de la batterie ! Respecter les consignes de sécurité du constructeur automobile !
- Veiller à n'endommager aucune pièce du véhicule en perçant des trous.
- La section du câble (+) et (-) ne doit pas dépasser 1,5 mm².
- **Ne pas brancher les connecteurs du véhicule sur la radio !**
- Les câbles d'adaptation nécessaires pour le type de véhicule sont disponibles auprès des revendeurs BLAUPUNKT.
- En fonction du modèle, votre véhicule peut différer de cette description. Nous déclinons toute responsabilité en cas de dommages causés

par des erreurs de montage ou de connexion et en cas de dommages consécutifs.

Si les indications décrites ici ne s'appliquent au montage que vous voulez effectuer, adressez-vous à votre revendeur Blaupunkt, votre constructeur automobile ou notre service d'assistance téléphonique.

Pour le montage d'un amplificateur ou changeur, les masses d'appareil doivent être d'abord connectées avant de connecter les fiches pour les connecteurs Line In ou Line Out.

Les masses des appareils externes ne doivent pas être raccordées à la masse de l'autoradio (boîtier).



Istruzioni di installazione



Note di sicurezza

Durante il montaggio e l'allacciamento osservate per favore le seguenti istruzioni sulla sicurezza.

- Staccate il polo negativo della batteria! Nel fare ciò osservate le istruzioni di sicurezza del fabbricante d'auto.
- Quando praticate dei fori, fate attenzione a non danneggiare nessuna parte dell'autovettura.
- La sezione dei cavi positivi e negativi non deve essere mai inferiore a 1,5 mm².
- **Non collegare alla radio le spine in dotazione di autovettura!**

- Richiedete ad un negoziante specializzato in articoli BLAUPUNKT il cavo di adattamento richiesto per il vostro modello di autovettura.
- A seconda del modello il Suo veicolo può differire da questa descrizione. Non forniamo garanzia per danni derivanti da errori di montaggio o di collegamento e per danni conseguenti.
Se le indicazioni qui elencate non sono adatte al Suo montaggio, La preghiamo di rivolgersi al Suo rivenditore Blaupunkt, al fabbricante dell'auto o alla nostra hotline telefonica.

Quando vengono montati un amplificatore o un multiletto CD, bisogna innanzi tutto allacciare le masse degli apparecchi prima di eseguire la connessione delle spine con le prese line-in e line-out.

Le masse di altri apparecchi non devono essere collegate alla massa dell'autoradio (involucro).

Inbowhandleiding

Adviezen voor de veiligheid

Wilt u dedurende het monteren en aansluiten de volgende veiligheidsadviezen in acht nemen.

- De minpool van de batterij afklemmen! De veiligheidsadviezen van de fabrikant in acht nemen.
- Bij het gaten boren erop letten dat geen voertuigonderdelen worden beschadigd.

- De dwarsdoorsnede van de plus-en minkabel mag niet minder dan 1,5 mm² zijn.
- **Stekker aan de voertuigkant niet aan de radio aansluiten!**
- de voor uw voertuig vereiste adapterkabel is bij de BLAUPUNKT-vakhandel verkrijgbaar!
- Afhankelijk van de uitvoering kan uw auto afwijken van deze beschrijving. Voor schade door fouten in montage of aansluiting en schade als gevolg daarvan aanvaarden wij geen aansprakelijkheid.

Mochten de hier vermelde aanwijzingen voor de montage voor u niet van toepassing zijn, dan kunt u contact opnemen met uw Blaupunkt-vakhandel, uw autofabrikant of onze telefoon-hotline.

Bij inbouw van een versterker of cd-wiselaar moeten eerst de massacontacten van de apparaten worden verbonden voordat de stekkers voor de line-in- of line-out-bussen worden aangesloten.

De massa van andere apparaten mag niet aan de massa van de autoradio (huis) worden aangesloten.

Monteringsanvisning

Skyddsanvisningar

- Vänligen beakta följande skyddsanvisningar under pågående montage och anslutning.
- Lossa polskan från batteriets minuspol! Följ därvid fordonstillverkarens skyddsanvisningar.

-
- Se till att inga av fordonets komponenter skadas i samband med borrar av hål.
 - Plus- och minuskabelns ledningsarea måste vara minst 1,5 mm².
 - **Fordonets stickkontakt får inte anslutas till radion!**
 - Din BLAUPUNKT fackhandel tillhandahåller för resp fordonstyp erforderlig adapterkabel.
 - Beroende på konstruktionstyp kan fordonet avvika från denna beskrivning. Vi fransäger oss allt ansvar för skada eller följdskada pga. felaktig montering eller anslutning.

Om här givna monteringsanvisningar ej stämmer överens med faktiska förhållanden, vänligen kontakta Blaupunkt fackhandel, representant för fordonets tillverkare eller vår telefonkundtjänst.

Vid montering av förstärkare eller cd-växlare måste först apparatstommen jordas, innan stickpropparna ansluts till in- eller utgångarna (hylstag line-in resp line-out).

Jord från andra apparater får inte anslutas till bilradions jord (höljet).

**Mitgelieferte Montage- und
Anschlusssteile**
Supplied Mounting Hardware
Materiel de montage fourni
**Componenti di fissaggio comprese
nella fornitura**
Meegeleverde montagematerialen
Medföljande monteringsdetaljer

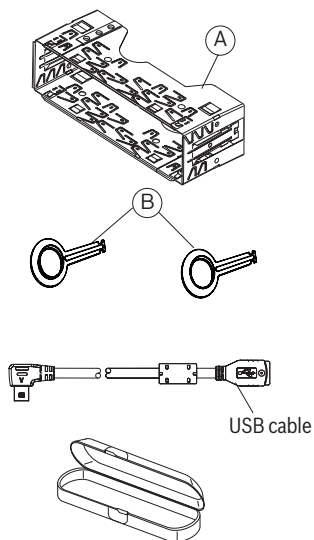

Als Sonderzubehör erhältlich
Available as an optional accessory
Disponibile en option
Reperibili come accessori extra
Als speciale accessoire verkrijgbaar
Tillval

Preamp./Sub./Center - out cable

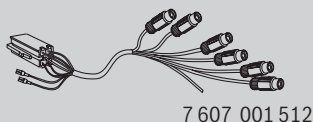

7 607 001 512

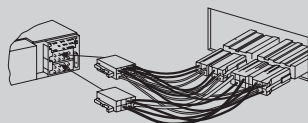

7 607 621 ...

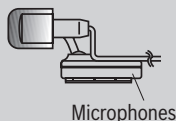

7 607 001 511

Microphones

Einbausätze
Installation kits
Kits de montage
Set di montaggio
Inbouwsets
Monteringsatser

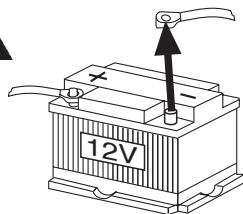
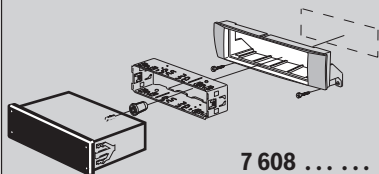

2.

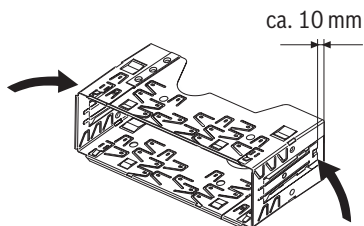

3.

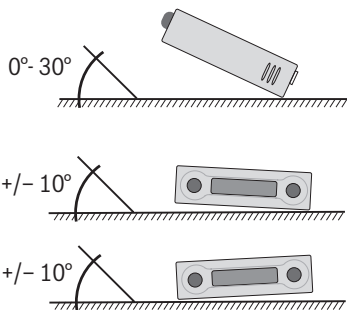

4.

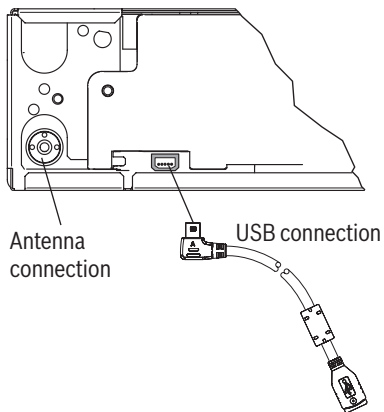

5.

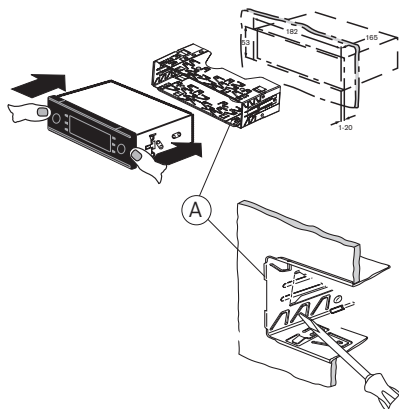

6. Ausbau / Removal / Démontage /
Smontaggio / Demontage /
Urmontering

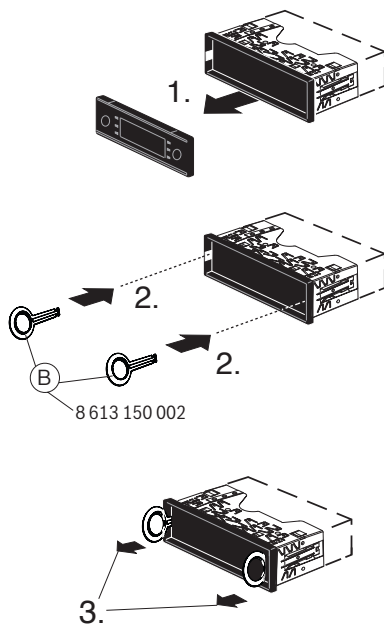

7.

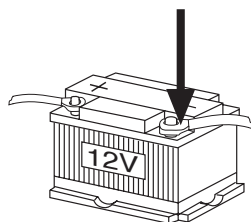

8.

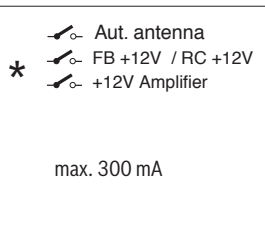
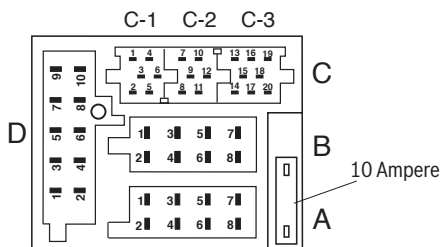

A		B	
1	No connection	1	Speaker out RR+
2	Radio Mute	2	Speaker out RR-
3	Sub-out	3	Speaker out RF+
4	Permanent +12V	4	Speaker out RF-
5	Aut. antenna	5	Speaker out LF+
6	Illumination	6	Speaker out LF-
7	Kl.15/Ignition*	7	Speaker out LR+
8	Masse/GND	8	Speaker out LR-

D	
1	AUX 2 NF L
2	AUX 2 NF R
3	AUX 2 GND
4	NC
5	NC
6	NC
7	NC
8	NC
9	MIC GND
10	MIC INPUT

C					
C1		C2		C3	
1	Line Out LR	7	Telefon NF in +	13	CDC-Data - In
2	Line Out RR	8	Telefon NF in -	14	CDC-Data - Out
3	Line Out / Ground	9	Radio Mute	15	Permanent +12V
4	Line Out LF	10	RC +12V *	16	+12V *
5	Line Out RF	11	Remote Control	17	Bus / GND
6	+12V Amplifier *	12	RC - GND	18	AF / GND
				19	CDC Line In - L
				20	CDC Line In - R

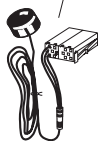
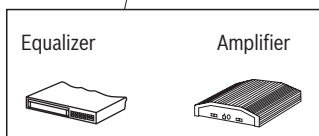

Optional
(Remote Control Eye)

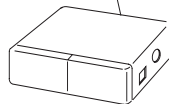

CD-Changer

Bitte den ausgefüllten Gerätepass sicher aufbewahren!
Please keep the filled-in radio pass in a safe place!
Prière de conserver soigneusement la carte d'autoradio remplie !
Tenete per favore il libretto di apparecchio, debitamente riempito, in un posto sicuro!
Bewaar de ingevulde apparaatpas op een veilige plaats!
Vänligen förvara ifyllt apparatpass på säker plats!

Country:	Phone:	Fax:	WWW:
Germany	(D) 0180-5000225	05121-49 4002	http://www.blaupunkt.com
Austria	(A) 01-610 39 0	01-610 39 391	
Belgium	(B) 02-525 5444	02-525 5263	
Denmark	(DK) 44 898 360	44-898 644	
Finland	(FIN) 09-435 991	09-435 99236	
France	(F) 01-4010 7007	01-4010 7320	
Great Britain	(GB) 01-89583 8880	01-89583 8394	
Greece	(GR) 210 94 27 337	210 94 12 711	
Ireland	(IRL) 01-46 66 700	01-46 66 706	
Italy	(I) 02-369 62331	02-369 62464	
Luxembourg	(L) 40 4078	40 2085	
Netherlands	(NL) 0800 400 1010	0800 400 1040	
Norway	(N) 66-817 000	66-817 157	
Portugal	(P) 2185 00144	2185 00165	
Spain	(E) 902 52 77 70	91 410 4078	
Sweden	(S) 08-7501850	08-7501810	
Switzerland	(CH) 01-8471644	01-8471650	
Czech. Rep.	(CZ) 02-6130 0446	02-6130 0514	
Hungary	(H) 76 511 803	76 511 809	
Poland	(PL) 0800-118922	022-8771260	
Turkey	(TR) 0212-335 06 71	0212-346 00 40	
USA	(USA) 800-2662528	708-6817188	
Brasil (Mercosur)	(BR) 0800 7045446	+55-19 3745 2773	
Malaysia (Asia Pacific)	(MAL) +604-6382 474	+604-6413 640	

Gerätepass

Name: **Memphis MP66**

Typ: **7 646 ...**

Serien-Nr: **BP**

 **BLAUPUNKT**

Blaupunkt GmbH, Robert-Bosch-Straße 200, D-31139 Hildesheim

09/07 - CM:AS/SCS

(dt, gb, fr, it, nl, sw)



8622404853